



# International Skeleton Rules

2017

## Table of Contents

1.	IBSF COMPETITIONS .....	5
1.1	<i>Olympic Winter Games</i> .....	5
1.1.1	Senior Olympic Winter Games.....	5
1.1.2	Youth Olympic Winter Games.....	5
1.2	<i>Championships</i> .....	5
1.2.1	Senior World Championships .....	5
1.2.2	Junior World Championships .....	5
1.2.3	Continental Championships.....	5
1.2.4	Junior Continental Championships .....	5
1.2.5	Para World Championships .....	5
1.2.6	Summer Push World Championships .....	5
1.3	<i>Official IBSF Competitions</i> .....	5
1.3.1	World Cup Competitions .....	5
1.3.2	Intercontinental Cup Competitions.....	5
1.3.3	Europe Cup and North American Cup Competitions.....	5
1.3.4	IBSF Sanctioned Competitions .....	5
1.3.5	Para World Cup Competitions .....	5
1.3.6	Youth Competitions .....	5
1.3.7	Summer Push Competitions .....	5
1.4	<i>Test Competitions and International Training Period</i> .....	5
1.5	<i>Allocation of Competitions</i> .....	6
1.6	<i>Gender</i> .....	6
2.	DISCIPLINES.....	7
2.1	<b>Men's Skeleton</b> .....	7
2.2	<b>Women's Skeleton</b> .....	7
2.3	<i>Team Competition</i> .....	7
2.4	<i>Other Disciplines</i> .....	7
2.4.1	Para Skeleton .....	7
2.4.2	Summer Push.....	7
2.4.3	Youth Competitions .....	7
3.	ADMISSION.....	7
4.	RIGHT TO PARTICIPATE IN COMPETITIONS .....	8
4.1	<i>Olympic Winter Games</i> .....	8
4.2	<i>Senior World Championships</i> .....	8
4.2.1	Requirements for participation in the Senior World Championships.....	8
4.3	<i>Junior World Championships</i> .....	8
4.3.1	Requirements for participation in the Junior World Championships: .....	8
4.4	<i>Continental Championships</i> .....	9
4.5	<i>World Cup and Intercontinental Cup</i> .....	9
4.5.1	World Cup.....	9
4.5.2	Intercontinental Cup .....	9
4.6	<i>Europe Cup and North American Cup</i> .....	9
4.6.1	Europe Cup.....	10
4.6.2	North American Cup.....	10
4.7	<i>IBSF Sanctioned Competitions</i> .....	10
5.	EVENT .....	10
5.1	<i>General</i> .....	10
5.2	<i>Costs</i> .....	10
5.3	<i>Track</i> .....	10
5.4	<i>Event Announcements and Invitations</i> .....	10
5.5	<i>Organising Committee and Race Director</i> .....	11
5.6	<i>Technical Equipment</i> .....	11
5.7	<i>Liability Insurance</i> .....	12
5.8	<i>Further Obligations of the Organiser</i> .....	12
6.	JURY AND TECHNICAL DELEGATES .....	12
6.1	<i>Jury License</i> .....	12
6.2	<i>License for Material Controls</i> .....	12

6.3	<i>Nomination</i> .....	12
6.3.1	Olympic Winter Games .....	12
6.3.2	Senior World Championships .....	13
6.3.3	Junior World Championships, Continental Championships, World Cup and Intercontinental Cup .....	13
6.3.4	Europe Cup and North American Cup.....	13
6.3.5	IBSF Sanctioned Competitions .....	13
6.4	<i>Authority</i> .....	13
6.4.1	Jury.....	13
6.4.2	Technical Delegates.....	14
6.4.3	Attendance.....	14
6.4.4	Expenses .....	14
6.4.5	Authority to Inspect.....	14
6.4.6	Special Decisions.....	14
7.	RACE DIRECTOR .....	14
7.1	<i>Appointment</i> .....	14
7.2	<i>Duties</i> .....	14
8.	GENERAL REGULATIONS .....	15
8.1	<i>Sporting Year</i> .....	15
8.2	<i>Liability</i> .....	15
8.3	<i>Amateurism Rules</i> .....	15
8.4	<i>Licenses</i> .....	15
8.5	<i>Insurance</i> .....	15
8.6	<i>Entries</i> .....	15
8.7	<i>Acceptance of the International Rules</i> .....	16
8.8	<i>Track Records and Start Records</i> .....	16
8.9	<i>Doping Controls</i> .....	16
8.10	<i>Rule Violations</i> .....	16
8.10.1	Athlete Support Person Rule Violations .....	17
8.10.2	Prohibited Association .....	17
8.10.3	Burden of Proof.....	17
8.11	<i>Sponsorship and Advertising</i> .....	17
8.12	<i>Trademarks on Equipment</i> .....	17
8.12.1	IBSF Properties .....	17
8.12.2	Freely Available Advertising Areas .....	17
9.	MEDICAL SERVICE AT THE TRACK.....	18
9.1	<i>Race Medical</i> .....	18
9.2	<i>Team Medical/Doctor</i> .....	18
9.3	<i>Evacuation of injured athletes</i> .....	18
10.	THE COMPETITION .....	19
10.1	<i>Official Training</i> .....	19
10.1.1	Olympic Winter Games and Senior World Championships .....	19
10.1.2	Continental Championships, World Cup and Intercontinental Cup .....	19
10.1.3	Junior World Championships, Europe Cup and North American Cup .....	19
10.1.4	IBSF Sanctioned Competitions .....	19
10.1.5	Changes to Official Training .....	19
10.2	<i>Starting Order during Training</i> .....	19
10.3	<i>Track Conditions during Training</i> .....	19
10.4	<i>Start Grooves</i> .....	20
10.5	<i>Replacement of Athletes</i> .....	20
10.6	<i>The Race</i> .....	20
10.6.1	Race Heats .....	20
10.6.2	Starting Order .....	20
10.6.3	Starting Order System .....	21
10.6.4	Start Number .....	21
10.6.5	Athletes and Manner of driving .....	22
10.6.6	Track Conditions during the Race .....	22
10.6.7	Track Walks.....	22
10.6.8	Start .....	22
10.6.9	Reduction.....	22

10.6.10	Interruption or Cessation.....	22
10.6.11	Repetition of a Heat .....	23
10.6.12	Replacement Races .....	23
10.6.13	Pilot Sleds.....	23
10.6.14	Timing Equipment specifications.....	23
10.6.15	Time Measurement .....	24
10.6.16	Maintenance of the timing equipment (in place from 2017/18 season on) .....	24
10.6.17	Use of push start facility.....	24
10.7	<i>Parc Fermé</i> .....	24
10.8	<i>Material and Equipment</i> .....	24
10.8.1	Sled.....	24
10.8.2	Runners (General).....	25
10.9	<i>Technical Inspections</i> .....	25
10.10	<i>Runner Diameter</i> .....	26
10.11	<i>Measurement of Runner Temperatures</i> .....	26
10.12	<i>Reference Runner</i> .....	27
10.13	<i>Runner Cleaning</i> .....	27
10.14	<i>Weight</i> .....	27
10.15	<i>Electronic Measuring Devices and Equipment</i> .....	28
10.16	<i>Other Equipment</i> .....	28
10.16.1	Helmet.....	28
10.16.2	Shoes.....	28
10.16.3	Clothing .....	29
10.17	<i>Awards</i> .....	29
10.17.1	IBSF Championships.....	29
10.17.2	Official IBSF Competitions .....	29
10.18	<i>Awards Ceremony</i> .....	29
10.19	<i>Protests</i> .....	29
11.	RANKING LISTS .....	30
11.1	<i>Ranking List of the Race Series</i> .....	30
11.2	<i>IBSF Ranking List</i> .....	30
11.3	<i>IBSF Ranking List - Points</i> .....	31
12.	SKELETON SLEDS WITH DRAWINGS .....	32
12.1	<i>Basic Principles</i> .....	32
12.2	<i>Construction</i> .....	32
12.3	<i>Dimensions (Figures 1, 2 &amp; 3)</i> .....	33
12.4	<i>Construction Frame (Figures 1 &amp; 2)</i> .....	33
12.5	<i>Saddle (Figures 1, 2 &amp; 3)</i> .....	33
12.6	<i>Cowling</i> .....	34
12.7	<i>Weights</i> .....	34
12.8	<i>Runners (Figure 5)</i> .....	34
12.9	<i>Bumpers (Figures 1, 2 &amp; 3)</i> .....	34
12.10	<i>Sled Coverings</i> .....	35
12.11	<i>Drawings</i> .....	36
12.12	<i>Equipment</i> .....	39
13.	MATERIAL SEIZURE .....	40
13.1	<i>Procedure for the seizure of sled components for conformity tests</i> .....	40
13.2	<i>The Form</i> .....	40
13.3	<i>The Container</i> .....	40
13.4	<i>Remarks</i> .....	40
14.	ADVERTISING GUIDELINES AND DRAWINGS .....	42
15.	FINAL CLAUSES.....	43
15.1	<i>Coming into Force</i> .....	43
15.2	<i>Modifications</i> .....	43
15.3	<i>Interpretation</i> .....	43
GLOSSARY	.....	44

## 1. IBSF COMPETITIONS

The IBSF competitions consist of the following events:

- 1.1 Olympic Winter Games
  - 1.1.1 Senior Olympic Winter Games
  - 1.1.2 Youth Olympic Winter Games
  
- 1.2 Championships
  - 1.2.1 Senior World Championships
  - 1.2.2 Junior World Championships
  - 1.2.3 Continental Championships
  - 1.2.4 Junior Continental Championships
  - 1.2.5 Para World Championships
  - 1.2.6 Summer Push World Championships
  
- 1.3 Official IBSF Competitions
  - 1.3.1 World Cup Competitions
  - 1.3.2 Intercontinental Cup Competitions
  - 1.3.3 Europe Cup and North American Cup Competitions
  - 1.3.4 IBSF Sanctioned Competitions
  - 1.3.5 Para World Cup Competitions
  - 1.3.6 Youth Competitions
  - 1.3.7 Summer Push Competitions

### 1.4 Test Competitions and International Training Period

The Organisers of IBSF competitions to be staged on newly constructed tracks shall offer all Members enough training in advance, during the preceding season respectively during the same season of the competition.

Training runs prior to races are to be offered also on any tracks that have been subject to constructional changes.

The Organisers of the Winter Olympic Games to be staged on newly constructed tracks shall offer a number of at least 40 training and competition runs prior to the Games to all Members. These training runs and competition runs must be offered in the form of two or more International Training periods, scheduled throughout the season.

Prior to the Games, the Organisers must also hold at least one test competition.

The quotas for participation in the International Training periods and in the test event are the same as for the World Cup of the season in which the International Training periods and/ or test event are held.

Furthermore the following nations can participate in the International Trainings periods and/or test event with 1 male or 1 female athlete:

- men the first 7 nations,
- women the first 5 nations

not qualified for the World Cup, provided that these athletes have taken part in and been ranked in, a minimum of 5 IBSF competitions on a minimum of 3 different tracks in the course of the previous 24 months.

Nations that do not have the right to compete in the World Cup, may not participate with their athletes in **the "Test event" but their athletes can train during this time.**

Moreover, for reasons of fairness and safety, immediately prior to the start of official training for the Olympic competitions (whether before or after the Opening Ceremony), the athletes (male and female athletes) registered for the Games must be given the possibility of at least 4 training runs.

Male and female athletes who in the previous and/or current season placed in the top 15 of the IBSF rankings for discipline cannot do additional training runs beyond the number prescribed by the present Article. This does not apply to athletes from the host country.

Moreover, the Organiser of the trainings periods and Test Event must grant that all participating athletes and their assistants/coaches will be provided with lodging in at least a three star hotel, full board, at a maximum price of € 80 per day.

The Organisers of the World Championships must offer an International Training period, to prepare for the championships and it must take place during the same competitive season in which the World Championships are organised. They are exempt from doing this if during the preceding competitive season a World Cup competition had been organised on the same track.

During the training periods in preparation for the Winter Olympic Games and/or World Championships, the Organiser shall offer training runs upon payment of the following amount: a maximum of € 12 for each skeleton training run shall be offered.

If the training period is to be staged as a test competition, the Organiser must offer the runs free of charge.

However, the Organiser may require payment of the entry fee.

## 1.5 Allocation of Competitions

### a) World Championships

The Congress assigns the World Championships to the respective Member Federations a maximum of four years in advance upon written application.

### b) Official IBSF Competitions

The remaining official IBSF competitions are assigned yearly by the IBSF Executive Committee, and must be listed on the IBSF International Calendar.

## 1.6 Gender

If the IBSF International Rules do not explicitly indicate the gender, they apply to both men's and women's skeleton.

## 2. DISCIPLINES

The following disciplines are contested:

### 2.1 **Men's Skeleton**

### 2.2 **Women's Skeleton**

### 2.3 Team Competition

### 2.4 Other Disciplines

#### 2.4.1 Para Skeleton

see IBSF Para Skeleton Rules

#### 2.4.2 Summer Push

see IBSF Summer Push Rules

#### 2.4.3 Youth Competitions

see IBSF Youth Rules

## 3. ADMISSION

The right to participate in championships and official IBSF competitions is reserved only for athletes registered by IBSF Members.

The athletes must fulfill one of the following conditions:

- They must hold citizenship of the country of the Member concerned, and may not have taken part in international IBSF competitions on behalf of another Member, or
- They must have their official residence in the country of the Member concerned, and may not have taken part in international IBSF competitions on behalf of another Member, or
- They must have changed their citizenship or their official residence, and have been released by their former Member and accepted by their new Member. In this case, the athlete may represent one of the two Members, but not both.

An athlete may represent only one nation during any competition season, which lasts from October 1<sup>st</sup> to September 30<sup>th</sup> of the following year.

Applications to change Federations may only be submitted between March 31<sup>st</sup> and September 30<sup>th</sup> of each year.

When athletes switch nations, they keep their scores and ranking in the IBSF Ranking List, as well as the number of competitions in which they have participated; however, they do not keep the right to the previous quotas for participation, which remains tied to the nation of origin.

## 4. RIGHT TO PARTICIPATE IN COMPETITIONS

### 4.1 Olympic Winter Games

The criteria for the right to participate in the Olympic Winter Games are determined by the IOC. The qualification rules are determined by the IOC in collaboration with the IBSF. The qualification rules are communicated directly by the IOC to all National Olympic Committees. For the Olympic Winter Games the IBSF Discipline Ranking List will be cleaned of all athletes representing a nation that has already reached its maximum amount of quota spots available for the competition. E.g. If Nation A has 3 quota spots, all Nation A's other athletes on the List will be taken out of the list, allowing other Nations athletes to move up the List.

### 4.2 Senior World Championships

The Senior World Championships take place annually, with the exception of the Olympic year. Quotas are based on the current IBSF Ranking List.

The quotas for participation in the Senior World Championships are as follows:

Men:	Nations with 3 athletes in the Top 30: 3 starting places
	Nations with 2 athletes in the Top 50: 2 starting places
	Nations with 1 athlete in the Top 60: 1 starting place
	All remaining nations with 1 athlete
Women:	Nations with 3 athletes in the Top 25: 3 starting places
	Nations with 2 athletes in the Top 35: 2 starting places
	Nations with 1 athlete in the Top 45: 1 starting place
	All remaining nations with 1 athlete

The defending Junior World Champion is also entitled to participate.

#### 4.2.1 Requirements for participation in the Senior World Championships

Participation is allowed only for athletes who have taken part in, and been ranked in, a minimum of 5 IBSF competitions on a minimum of 3 different tracks in the course of the previous 24 months prior to the competition. In addition the athletes must have been ranked in at least 3 of these 5 races on a minimum of 2 different tracks during the on-going season.

### 4.3 Junior World Championships

The Junior World Championships take place annually. Only athletes from the Junior category may participate. All National Federations may participate with a maximum of 3 athletes.

#### 4.3.1 Requirements for participation in the Junior World Championships:

Participation is allowed only for athletes who have taken part in, and been ranked in, a minimum of 3 IBSF competitions on a minimum of 2 different tracks in the course of the previous 24 months.

Juniors are athletes who have not yet reached the age of 23 years on the date of the Junior race.

Furthermore, Juniors are all those athletes who reach the age of 23 years in the period of October 1<sup>st</sup> to March 31<sup>th</sup> of the current season.



#### 4.4 Continental Championships

The quotas for participation in the Continental Championships are identical to those of the World Cup if the Championships are held within the course of a World Cup competition. Nations of the respective continent that are not qualified to participate in the World Cup have the right to participate with one athlete. These athletes are ranked only in the Continental Championships and shall receive no World Cup points. They are drawn separately at the end of the field of competitors.

These athletes start at the end of the field of competitors corresponding to their place in the IBSF rankings. The starting order for athletes without points is drawn by raffle.

In the second race heat, they start according to their ranking after the first heat.

The Junior European Champion will be the Junior athlete with the highest points within the Europe Cup Ranking List by the end of the season. In relation to the Junior European Championships Juniors are athletes who have not yet reached the age of 23 years on the date of the Junior race. Furthermore, Juniors are all those athletes who reach the age of 23 years in the period of October 1<sup>st</sup> to March 31<sup>th</sup> of the current season.

#### 4.5 World Cup and Intercontinental Cup

**Quotas for the new season are based on the final results of the previous year's IBSF Ranking List.**

##### 4.5.1 World Cup

The quotas for participation are determined as follows:

- Men: Nations with 3 athletes in the Top 30: 3 starting places
- Nations with 2 athletes in the Top 50: 2 starting places
- Nations with 1 athlete in the Top 60: 1 starting place
- Women: Nations with 3 athletes in the Top 25: 3 starting places
- Nations with 2 athletes in the Top 35: 2 starting places
- Nations with 1 athlete in the Top 45: 1 starting place

##### 4.5.2 Intercontinental Cup

The quotas for participation are determined as follows:

- Men: Nations with 3 athletes in the Top 60: 3 starting places
- Nations with 2 athletes in the Top 75: 2 starting places
- All remaining Nations with 1 athlete
- Women: Nations with 3 athletes in the Top 45: 3 starting places
- Nations with 2 athletes in the Top 60: 2 starting places
- All remaining Nations with 1 athlete

Requirement for participation in the Continental Championships, World Cups and Intercontinental Cups: Participation is allowed only for athletes who have taken part in, and been ranked in, a minimum of 5 IBSF competitions on a minimum of 3 different tracks in the course of the previous 24 months.

#### 4.6 Europe Cup and North American Cup

**Quotas for the new season are based on the final results of the previous year's IBSF Ranking List.**

The athletes placed among the top 15 of the current **season's or previous season's (until the beginning of the current season's)** IBSF ranking will not be admitted either to the Europe Cup races or to the North American Cup races.

#### 4.6.1 Europe Cup

The quotas for participation are determined as follows:

- Men: Nations from Europe and Africa with a maximum of 4 athletes.  
All remaining nations from America, Asia and Oceania with a maximum of 2 athletes.
- Women: Nations from Europe and Africa with a maximum of 4 athletes.  
All remaining nations from America, Asia and Oceania with a maximum of 2 athletes.

#### 4.6.2 North American Cup

The quotas for participation are determined as follows:

- Men: Nations from America, Asia and Oceania with a maximum of 4 athletes.  
All remaining Nations Europe and Africa with a maximum of 2 athletes.
- Women: Nations from America, Asia and Oceania with a maximum of 4 athletes.  
All remaining Nations Europe and Africa with a maximum of 2 athletes.

#### 4.7 IBSF Sanctioned Competitions

The Organiser together with the IBSF will establish the right to participate, but at a minimum there must be 2 nations per discipline. All IBSF rules and regulations apply unless specifically stated elsewhere in these rules. An athlete may count one (1) of these races as participation in other IBSF competitions.

### 5. EVENT

#### 5.1 General

Only the IBSF, as well as its Members, have the right to organise international competitions. All official international IBSF competitions shall be organised under the supervision of the IBSF. The IBSF shall award the competition to a Member that is able to undertake the organisation of the competition, or is able to pass it on to an association (Club) or an Organising Committee. The Member remains responsible for the orderly execution of the event.

#### 5.2 Costs

The Organiser to whom the Organisation of the event has been awarded assumes the entire organization and its costs.

#### 5.3 Track

The Organiser shall make the track available in the best possible condition for the official training and the race. The usage of the track during the official training and the race is free of charge.

#### 5.4 Event Announcements and Invitations

The Organiser of the competition shall be responsible for the event announcements and invitations. The Organiser must present the official event announcement with the program schedule to the IBSF Executive Committee for approval by August 15<sup>th</sup>. The Organiser must send the program schedule to the Member Federations and the appointed Jury Members within two weeks of receiving the approval of the IBSF.

The event announcement must include:

- the name of the competition
- the location and date of the competition
- a schedule for the official training and the race
- a short description of the track, including a sketch of the track
- the entry deadline
- the address of the Organising Committee with exact office times, telephone number, fax number and e-mail address
- the name of the Chief of Organisation
- the name of the Race Director
- the names of the Jury Members and the Technical Delegate, if any
- information about facilities, benefits and hotel accommodations
- any conditions of entry
- **the location and time of the first team captains' meeting**

#### 5.5 Organising Committee and Race Director

An Organising Committee and a Race Management Office shall be formed in order to guarantee the orderly execution of the event.

The Race Director must possess an IBSF International Jury License. He is responsible for ensuring that the entire event is carried out in accordance with the IBSF International Rules. He shall ensure that skilled and responsible people hold all the important positions in order to assure the smooth progression of the event. Furthermore, he is obliged to ensure that the track is in perfect condition and that the safety of the athletes, coaches and spectators is guaranteed.

#### 5.6 Technical Equipment

- voice communication among the start, the finish and the timekeepers
- voice communication between the Race Director and the Jury
- numerous loudspeakers
- at least two calibrated instruments for measuring runner temperature
- an electronic timing system
- **a room for team captains' meetings**
- sufficient changing rooms and sanitary facilities
- a weight scale, calibrated every year
- sufficient transport vehicles
- a first aid room
- medical service
- a doping control room
- video surveillance on the track
- a room suitable for technical inspections of sleds and runners
- a suitable room, possibly next to the start, equipped with Internet connection for the Jury
- sufficient computers and photocopiers
- a score board
- optical and acoustic devices to authorize the start
- barricade fences and tape for the Parc Fermé
- sufficient and suitable racks for positioning the sleds
- **A large television screen should be present at the start area during all World Cup events.**

## 5.7 Liability Insurance

The Organiser is obliged to obtain sufficient public liability insurance.  
The insurance must cover the IBSF staff involved in the respective competition.

## 5.8 Further Obligations of the Organiser

The obligations of the Organiser of IBSF competitions are specified in writing within the framework of a contract that is negotiated between the IBSF and the Organiser's **National Federation**. The Organiser shall make available all official times recorded during the trainings and the race to the team captains of all participating nations as quickly as possible, preferable by email or in an electronical way. The results should be accessible online. Upon request the official times can be printed. Race results must be forwarded to the media and the IBSF immediately after the conclusion of the event.

# 6. JURY AND TECHNICAL DELEGATES

## 6.1 Jury License

The Jury Members and Technical Delegates, appointed by the IBSF Executive Committee, must possess an IBSF International Jury License in order to officiate. Each National Federation has the right to recommend people suitable for obtaining an IBSF International Jury License.

This License can be acquired after taking an examination on the IBSF International Rules for Bobsleigh and Skeleton. In principle, the examinations take place two times per year, on the occasion of the Senior World Championships and of a World Cup competition on a different continent. The respective National Federations must register potential candidates with the IBSF Secretary General in advance (at least one month prior).

## 6.2 License for Material Controls

In order to be allowed to execute their office, the Material Controllers appointed by the Executive Committee must have an International Material Controller License of the IBSF. Each National Federation has the right to propose candidates who are eligible to obtain the International Material Controller License of the IBSF. The examinations will be held as specified by IBSF announcement. The respective National Federations must register potential candidates with the IBSF Secretary General in (at least one month prior).

## 6.3 Nomination

The IBSF Executive Committee nominates the Juries and the Material Controllers. The National Federations have the right to make recommendations.

### 6.3.1 Olympic Winter Games

- one or two Technical Delegates
- a Jury President
- two Jury Members
- two Jury Assistants, if required
- two or three Material Controllers

### 6.3.2 Senior World Championships

- one or two Technical Delegates
- a Jury President
- two Jury Members
- two Jury Assistants, if required
- two Material Controllers

### 6.3.3 Junior World Championships, Continental Championships, World Cup and Intercontinental Cup

- one or two Technical Delegates
- a Jury President
- two Jury Members
- Jury Assistants, if required
- two Material Controllers

### 6.3.4 Europe Cup and North American Cup

- one or two Technical Delegates
- a Jury President
- one or two Jury members
- one or two Material Controllers

### 6.3.5 IBSF Sanctioned Competitions

A Jury President or a Technical Delegate who represents the IBSF, with the task of controlling and supervising the event.

## 6.4 Authority

### 6.4.1 Jury

The Jury is the highest authority of the competition and implements control with the right to make final judgments within the scope of the IBSF International Rules.

The decision of the Jury is final, incontestable and takes effect immediately.

Furthermore, the Jury is responsible for:

- potential changes of the ice temperature
- any change of sleds
- any change of runners
- any repetition of a heat
- any reduction in the number of training runs
- any interruption or cessation of the race, after consultation with the Race Director and the Chief of Track
- any reduction in the number of participants
- any penalties for rule violations
- the length of the start grooves
- the number of pilot sleds
- the temperature and weight checks
- decisions regarding protests
- any suspension of athletes
- closing the track in case of danger

#### 6.4.2 Technical Delegates

During the Olympic Winter Games one Technical Delegate for Bobsleigh, one Technical Delegate for Skeleton and one additional Technical Delegate are to be appointed. During the Senior World Championships one Technical Delegate for Bobsleigh and one Technical Delegate for Skeleton are to be appointed.

In principle, for all other IBSF events only one Technical Delegate may be appointed for both disciplines.

The power to make decisions regarding the event lies exclusively with the Jury.

If no Technical Delegate has been appointed, the Jury President acts automatically also as Technical Delegate.

#### 6.4.3 Attendance

The Jury President must be available from the first **team captains' meeting onward**. The Jury is responsible for the compliance with the IBSF International Rules from the start of the official training to the end of the awards ceremony. In cases of absence of a Jury Member, the IBSF appoints a substitute.

#### 6.4.4 Expenses

The IBSF Executive Management Committee determines annually the reimbursement of allowable expenses of the Jury and the Technical Delegate, and informs all concerned by circular letter.

#### 6.4.5 Authority to Inspect

During the training and the race, the Technical Delegate and each Jury Member shall have access without prior notification to all technical equipment and facilities necessary to hold the competition.

#### 6.4.6 Special Decisions

The Jury is also responsible for all decisions pertaining to the competition that are not specified in these Rules.

## 7. RACE DIRECTOR

### 7.1 Appointment

The Race Director, appointed by the Organiser, must possess an IBSF International Jury License for all official IBSF competitions.

### 7.2 Duties

The Race Director is responsible for ensuring that, under the direction of the Jury, all measures are taken that are necessary for the orderly progression of the competition according to the IBSF International Rules. **This includes the progression of the team captains' meetings, the training and the race.**

Potential necessary changes taken on short notice must first be arranged with the Jury and the IBSF Coordinator.

The Race Director decides upon the use of sunshades during rain, snowfall, or sunshine. He shall inform the Jury President immediately about all decisions.

## 8. GENERAL REGULATIONS

### 8.1 Sporting Year

The sporting year of the IBSF runs from October 1<sup>st</sup> to September 30<sup>th</sup> of the following year.

### 8.2 Liability

The IBSF assumes no liability for accidents, damages, or other claims that should result from the allocation of the competition or from its proceedings.

### 8.3 Amateurism Rules

The rules of the IOC are adopted here.

### 8.4 Licenses

All athletes must be registered electronically by their National Federation for an IBSF International License prior to participating in the sport of skeleton.

The minimum age for athletes for obtaining an IBSF International License is 14-years of age. Athletes under the age of 18 require the permission of their parents or legal guardian in order to exercise the sport of skeleton. The parents or legal guardian must sign the letter of permission and the signature must be certified.

The IBSF Electronic License must be filled out in all details and certified by the President or a duly authorized Officer of the National Federation and submitted with a digital photograph. By registering for a license, the National Federation verifies and confirms that the athlete:

- has had a medical check and has met the medical requirements for skeleton;
- is covered by insurance against accidents deriving from the practice of skeleton training or racing;
- is covered by insurance against liability;
- has been issued the IBSF International and Anti-Doping Rules;
- has signed a form in which the athlete declares compliance with the IBSF International and Anti-Doping Rules, and;
- has signed a copy of the IBSF Athlete Code of Conduct.

The license is valid for one season (October 1<sup>st</sup> to September 30<sup>th</sup>).

### 8.5 Insurance

The Member Federations of the IBSF are responsible for ensuring that each of their athletes is sufficiently covered by accident and disability insurance, as well as public and third party liability insurance. All risks that may arise from an accident must be completely covered by the insurance.

### 8.6 Entries

Prior to the deadline specified in the event announcement, the Members shall inform the Organiser of the competition online of the athletes to be entered in the competition.

The Members are obliged to inform the IBSF Secretary General of the names of those people who are authorized to submit entries.

**The name of the team captain shall be given to the Jury at the first team captains' meeting.**

The Members have the right to select the athletes that shall participate.

The entry fees belong to the Organiser and amount to the value of € 25 per athlete.

If the entry deadline specified in the event announcement is not observed, the entry can be accepted for a double entry fee.

Entries may be withdrawn at any time. Already paid entry fees are non-refundable.

**Entry fees must be paid at the first team captains' meeting.**

## 8.7 Acceptance of the International Rules

With the submission of the entry, the participants (athletes, team captains, coaches and support staff) accept these Rules as binding.

## 8.8 Track Records and Start Records

Track records and start records will only be recognized by the IBSF if they have been performed during official international IBSF races. The record may be recognized if the athlete has been subjected to a weight test and their sled to a technical inspection during the competition. If the record is equaled in a subsequent race heat, it does not count as a record. In the event of a draw in the same race heat, more than one athlete may be listed as the record holders. The record cannot be recognized until it has been stated that there have been no violations of the IBSF International Rules.

## 8.9 Doping Controls

Doping is prohibited.

The IBSF Executive Committee can arrange for doping controls at all IBSF competitions and at any time outside of the competitions.

The doping controls are carried out according to the IBSF Anti-Doping Regulations.

The IBSF Executive Committee can authorize international specialized facilities to carry out these controls.

By signing the IBSF International License, the athlete is obliged to accept the IBSF Anti-Doping Regulations and to submit to the controls determined by the IBSF Executive Committee.

By signing the Acknowledgement and Agreement, the athletes, team captains, technicians, coaches and support staff recognize the new IBSF Anti-Doping Regulations.

## 8.10 Rule Violations

The Jury is responsible for the compliance with the IBSF International Rules from the first team **captains' meeting to the end of the awards ceremony.**

The Jury determines the penalties for violations against the provisions of the IBSF International Rules according to the gravity of the offence:

- a warning
- a fine
- disqualification from the competition
- application for disqualification from other competitions to the Executive Committee
- application to the Executive Committee for withdrawal of the international License

The athlete concerned or his National Federation has the right to defend himself before a final decision is made regarding the cancellation of the IBSF International License.

The fine is collected by the Jury, which forwards it to the IBSF.



### 8.10.1 Athlete Support Person Rule Violations

An Athlete Support Person (Coach, sled or runner builder, physio or any other person) may be deemed to have broken or contributed to the breaking of IBSF Rules. In this case the Jury determines the penalties for violations against the provisions of the IBSF International Rules according to the gravity of the offence:

- a warning
- a fine
- disqualification from the competition / venue
- application for disqualification from future IBSF competitions to the Executive Committee

### 8.10.2 Prohibited Association

In the event that an Athlete Support Person is disqualified from an IBSF event or events (8.10.1) it is prohibited for an athlete (athletes, team or nation) to associate with this person for the duration of their disqualification. If after receiving a written warning the athlete (athletes, team or nation) continues to associate with the disqualified person the athlete (athletes, team or nation) may be given a

- fine
- disqualification from the competition
- disqualification from future competitions

In order for this provision to apply, it is necessary that the athlete (athletes, team or nation) has been advised in writing by the IBSF **of the Athlete Support Person's disqualifying status and the potential consequence of prohibited association** and that the athlete can reasonably avoid the association.

### 8.10.3 Burden of Proof

The burden shall be on the athlete (athletes, team or nation) to establish that any association with the Athlete Support Personnel described in Article 8.10.1 or 8.10.2 is not in a professional or sport-related capacity.

## 8.11 Sponsorship and Advertising

The IBSF and its Member Federations can negotiate contracts with commercial firms or organisations.

## 8.12 Trademarks on Equipment

### 8.12.1 IBSF Properties

The IBSF property areas for advertising with sponsors or similar entities are governed by the IBSF Advertising Guidelines. The specifications established therein shall be followed. Violations result in penalties.

### 8.12.2 Freely Available Advertising Areas

With the exception of the areas entitled to the IBSF in accordance with the IBSF Advertising Guidelines, unlimited advertising may be placed on the sled, the equipment and the athlete.

## 9. MEDICAL SERVICE AT THE TRACK

### 9.1 Race Medical

The following must be available at the track during the official training runs and the race heats:

- One medical specialist with knowledge of emergency medical aid
- One medical vehicle used as emergency ambulance
- One room exclusively used for first aid treatment – which is marked as such.

For race days in addition:

- **One medical doctor with knowledge of sports and able to decide “Fit to slide” – e.g. concussion...**

One medical vehicle must be present at all times on the track. In case the medical vehicle is leaving the track training/race must be stopped.

Should medical personal be medically required, training/race must be stopped.

The Organiser shall be attentive to this regulation, as the Organiser is responsible for compliance with these requirements.

The IBSF Medical Committee decides on any possible exceptions to the above. The Jury President must be informed of these exceptions prior to the start of the official training.

Tasks of the race medical:

- responsible for the first medical aid for injuries and illnesses of the athlete
- coordination of transportation of injured or ill athletes for further medical treatment
- after every crash, the athlete must come to the race medical for an examination in order to obtain the authorization to participate further in the training or in the race. If the race medical suspects a concussion or serious injury athletes license must be invalidated ("mark the box on the form"), he is entitled to prohibit the concerned athlete from further participation. In these cases, the race medical must immediately inform **the Jury President of the athlete's inability to** continue to participate in the competition, and the athlete is accordingly officially removed from the competition. The Jury President immediately will inform the IBSF office to temporarily unlicense the concerned athlete. The race medical must complete an Injury Registration Document after every examination of an injured athlete. At the end of the competition, all of these documents (including timesheets) must immediately be forwarded to the IBSF office and the Chairman of the IBSF Medical Committee.

Only a medical doctor can provide "Fit to slide" approval to return to sliding.

### 9.2 Team Medical/Doctor

Race medical/doctor and team medicals/doctors should cooperate on evaluation and treatment.

### 9.3 Evacuation of injured athletes

The event organisers must guarantee that injured athletes can be transported away from any point of the entire length of the track.

## 10. THE COMPETITION

During a competition (the official training and the race), athletes are not permitted to make runs on the track outside of the official schedule, nor are they permitted to conduct training or races on other tracks at the same time or compete on more than one circuit. However, athletes are allowed to conduct training or races on other tracks in the first week of a two-week competition.

The IBSF may establish a Travel Day in its schedules. On IBSF Travel days no athlete may participate in a training or race on that track.

### 10.1 Official Training

Participation in the official training is only permitted for athletes registered for the race.

#### 10.1.1 Olympic Winter Games and Senior World Championships

Directly prior to the race, 6 official training runs shall be offered.

#### 10.1.2 Continental Championships, World Cup and Intercontinental Cup

Directly prior to the race, 3 days of official training with a minimum total of 6 official training runs shall be offered.

#### 10.1.3 Junior World Championships, Europe Cup and North American Cup

Directly prior to the race, 3 days of official training with a minimum total of 6 official training runs shall be offered.

#### 10.1.4 IBSF Sanctioned Competitions

The Organiser together with the IBSF will determine the number of official training runs. A minimum of 3 official training runs must be offered.

#### 10.1.5 Changes to Official Training

The IBSF Executive Committee can modify the number of official training days and / or training runs in official IBSF competitions. However, the change in the number of official training days and / or training runs must be declared in the event announcement.

At all official IBSF competitions, each athlete must complete two training runs without accident to be allowed to participate in the race.

### 10.2 Starting Order during Training

**The starting order of the participating nations shall be drawn at the first team captains' meeting. If possible, the training is run according to "nation groups".**

A training group shall not exceed 10 athletes.

The following starting order applies for events in which the official training takes place for 2 or 3 days:

- 1st day: from nation 1 to the end
- 2nd day: from the end to nation 1
- 3rd day: start order according to the IBSF Ranking List (men and women train separately)

### 10.3 Track Conditions during Training

If possible, the final day of official training should take place at the same time as the race and the track preparation should correspond to the conditions of the race. No alterations to the track profile should be made after the final training session.

## 10.4 Start Grooves

The start grooves are determined by the Jury on the first day of training and can only be modified upon their command. Both grooves shall be prepared appropriately for skeleton runners (17 mm diameter).

## 10.5 Replacement of Athletes

It is possible to replace an athlete with another athlete from the same National Federation at any time during training. However, an athlete may only be replaced if the replacement athlete is still able to achieve the minimum number of accident-free training runs without a change in the program schedule. An athlete who carries out runs beyond the official training (for example, as a forerunner or in the **“guests” class**) **cannot take part** in the competition later on. The Jury can make an exception to allow **such athlete’s participation in the Team Competition; however, this exception must be declared during the first team captains’ meeting.**

Double Races:

National Federations may allow new athletes to compete in the second race of a competition. The Federations will, however, be allocated only the number of training runs corresponding to their quotas. The Federations themselves must allocate these among their athletes.

National Federations may register a maximum of two new athletes for the second race at a WC, ICC, NAC and EC competition.

These athletes must be **registered no later than the first team captains’ meeting and** will be allocated with the same number of training runs as the other athletes.

The replacement athlete must hold a valid IBSF International License.

## 10.6 The Race

### 10.6.1 Race Heats

An IBSF race can be held over 4 or 2 heats. A reduction in the number of heats is possible in cases of force majeure.

#### a) 4-Heat Races

In principle, the Olympic Winter Games and the Senior World Championships are held over 4 race heats.

#### b) 2-Heat Races

The Continental Championships, the Junior World Championships and all other official IBSF races are held over 2 heats. All athletes entered in the draw must conduct at least one race heat for the race to be officially valid.

### 10.6.2 Starting Order

Starting order for 2-heat races:

- 1st race heat: from 1 to the end
- 2nd race heat: from 20 to 1, according to the ranking of the first race heat

Starting order for 4-heat races:

- 1st race heat: from 1 to the end
- 2nd race heat: from 20 to 1 and from 21 to the end, according to the ranking of the first race heat
- 3rd race heat: from 1 to the end, according to the ranking after two race heats
- 4th race heat: from 20 to 1, according to the ranking after three race heats

### 10.6.3 Starting Order System

To hold a race, a minimum of 6 athletes from a minimum of 2 nations must participate.  
Olympic Winter Games, Senior World Championships and Junior World Championships

In order of their IBSF Discipline Ranking position, the 10 best-placed athletes in the current IBSF Discipline Ranking List who are present will choose their start numbers 6 to 15 for Men's Skeleton and 4 to 13 for Women's Skeleton. For Women's Skeleton the first three athletes will be drawn from the last five ranked athletes in the field. For Men's Skeleton the first five athletes will be drawn from the last seven ranked athletes in the field. All other athletes start according to the ranking in the current IBSF Discipline Ranking List from start number 16 (Men's Skeleton) or 14 (Women's Skeleton) to the end.

If only 10 or less athletes are registered for a race, all athletes may choose their start numbers. If 11 to 14 athletes are registered for the race, the 10 best placed athletes in the current IBSF Discipline Ranking List, who are present, may choose the start numbers 5 to 14 or 4 to 13 or 3 to 12 or 2 to 11. The start numbers 1 to 4/3/2/ are assigned to the remaining athletes by draw.

Where allowed in these Rules to choose their start numbers the best placed athlete who is present will choose first, the second best athlete will choose second and so on.

### Continental Championships, World Cup, Intercontinental Cup, Europe Cup and North American Cup

The season starts on the basis of the IBSF Ranking List from the previous season. The 10 best-placed athletes in the current IBSF Discipline Ranking List who are present are drawn for the assignment of start numbers 6 to 15 for Men's Skeleton and 4 to 13 for Women's Skeleton. For Women's Skeleton the first three athletes will be drawn from the last five ranked athletes. For Men's Skeleton the first five athletes will be drawn from the last seven ranked athletes. All other athletes start according to the ranking in the current IBSF Discipline Ranking List from start number 16 (Men's Skeleton) or 14 (Women's Skeleton) to the end.

If only 10 or less athletes are registered for a race, all athletes will be drawn. If 11 to 14 athletes are registered for the race, the 10 best placed athletes in the current IBSF Discipline Ranking List, who are present, will be drawn for the assignment of start numbers 5 to 14 or 4 to 13 or 3 to 12 or 2 to 11. The start numbers 1 to 4/3/2/ are assigned to the remaining athletes by draw.

Athletes without points are drawn at the end of the field.  
The Jury holds the draw in public. An electronic draw by computer is possible. The athletes keep their start numbers for the duration of the competition.

### 10.6.4 Start Number

The IBSF claims the rights for the start numbers (sled and shirt) for its sponsors. The start number shirts shall be worn during the race heats and the awards ceremony. They may be sewn along the sides, but otherwise they may not be aerodynamically modified, nor may they be attached by additional means. The IBSF supplies the athletes with the start numbers. The start number for the sled (not exceeding 18 cm x 12 cm) shall be attached to the rear third of the underside of the sled. The start number may not be modified in any way.

#### 10.6.5 Athletes and Manner of driving

All race heats must be run by the same athlete.

The race doctor or race medical and the Jury are authorized to prohibit athletes in inadequate mental or physical condition to compete.

Only driving from the headfirst prone position (lying on the stomach) is allowed. After the start (when timing commences at the 50 m point) during the race heat, the athlete is not allowed to lose contact with the sled.

The athlete must cross the finish line on his sled.

**The finish line beam must be broken by the athlete's helmet.**

#### 10.6.6 Track Conditions during the Race

The track is prepared after agreement among the Jury, the Race Director and the Chief of Track.

In case of snowfall, it shall be made certain that a regularly scheduled race is possible. Particular attention shall be paid to the ice surface at the start up to the start time measurement (50 m), which shall be swept prior to the start of each sled. In particular, the start grooves are to be swept. The track must be swept regularly. The race director must prepare a written protocol for sweeping in consultation with the Jury. The written protocol has to be announced no later than the final Team Captains Meeting.

#### 10.6.7 Track Walks

The times for the track walks are determined after agreement between the Race Director and the Jury, and are disclosed at the **first team captains' meeting**. Track walks are not allowed outside of these times. Entering the track during a run is absolutely prohibited.

There are no track walks on race days.

#### 10.6.8 Start

The Jury defines a zone behind the start block that allows the athlete the necessary quiet for his preparations for the start. This zone may only be entered by the athlete, one coach and the Jury.

The start block may be stepped upon during the start procedure, but the rear edge may not be crossed.

The start line (the first timing point) must be clearly visible.

The athlete shall be present after the call to the start.

The starter clears the track by means of acoustic and optical signals. The athlete at the start must activate the timing device within 30 seconds.

The athletes can accelerate the sled by pushing it.

After the athlete has left the startblock the help from the third party during the start procedure while training and race is prohibited.

#### 10.6.9 Reduction

If the number of registered athletes exceeds the capacity of the track, the Jury, in agreement with the Technical Delegate and the Race Director, can reduce the number of participants.

All registered athletes must be allowed to compete in the first heat.

The number of athletes can be reduced before each subsequent race heat.

The starting order does not change in such case.

#### 10.6.10 Interruption or Cessation

The Jury, in consultation with the Technical Delegate, the Race Director and the Chief of Track, can interrupt or stop the race for the following reasons, among others:

- damage to the track
- weather conditions
- failure of the timing system or other technical equipment

After an interruption, the athlete at the start shall be granted a suitable amount of preparation time.

#### 10.6.11 Repetition of a Heat

After a malfunction not caused by the athlete, the heat may be repeated with the authorization of the Jury.

The run may be repeated as soon as the athlete is ready to start.

#### 10.6.12 Replacement Races

If a race is cancelled, the IBSF Executive Committee can decide to hold a replacement race at a later date on the same or a different track.

The following athletes may participate in the replacement race:

- all athletes eligible to participate, if the race concerned was cancelled prior to issuing the start numbers, or
- only those athletes who have received a start number for the cancelled race. Another drawing of the start numbers is carried out.

#### 10.6.13 Pilot Sleds

The Jury determines the number of pilot sleds. The Organiser is obliged to provide a minimum of three pilot sleds. Before skeleton races, only skeleton sleds should be used.

If the Jury decides there are an insufficient number of pilot sleds available, the Jury can appoint athletes that are last in the starting order. These athletes start immediately after the pilot sleds, and their pilot run is also scored as a race heat.

The Race Organiser is fully responsible for the selection of the pilot sleds.

#### 10.6.14 Timing Equipment specifications

a) Two independent timing systems, each consisting of at least one time measuring device, complete set of light beams and independent power supply, must be available and in operation during a competition (A and B systems).

b) The A system comprises all light beams for start, start time, four intermediate times, four speeds and finish time. The first interval time corresponds to the start time (50 m). Four interval times must be evenly distributed among the remainder of the track. For TV and Security reasons minimum 3 more light beams have to be set between Intermediate times and Speed traps in longer unmonitored parts of the track.

c) The B system comprises at least the start and finish light beams to record the run time. If a track is assigned to held Olympic Winter Games the B system has to be a 100% backup of the A system.

d) The time of day of both timing systems (A and B systems) must be synchronized and must provide accurate timing of 1/100 of a second.

e) All times have to be measured as Day Times. Intermediate times and Finish times are calculated by subtraction of Start time from Intermediate time or Start time from Finish time respectively. The result has to be truncated to 1/100 of a second.

f) Two evaluation and control computers for the timing system must be available and in operation during a competition.

g) The times measured by both timing systems must be recorded in both evaluation and control computers of the timing system.

h) In case of failure of the A system it must be possible to switch to the B system without time delay. After this, the times measured by the B system will be used for the continuation of the competition. The times recorded by the A system up to this point will remain valid.

i) In case of failure of the evaluation and control computer currently operating, it must be possible to switch to the second computer for controlling the timing system within a short time frame. The ranking valid up to this point is to be saved.

j) A check list has to be prepared by the Track operators detailing the switching between the two timing systems and the two control computers.

k) Independently from the computer, the light beam times recorded by each timing system must be

printed as daytimes on a corresponding timeline printer.

l) For external service providers an online data interface must be available through which they can obtain the measured light beam times (e. g. when TV graphics are required)

m) Uninterrupted power supply must be available for the timing system (time measuring devices and control computers) securing that at least the time of the current sled to the finish is recorded. The power supply of the light beams of the A and B systems must be independent from each other.

#### 10.6.15 Time Measurement

The Organisers have to hand over Time measurements to TD/Coordinator at the end of the competition.

Times equal to 1/100th of a second are given the same rank.

If two or more athletes achieve the same time in the first, second or third heats, the starting order for these athletes in the second, third and fourth heats respectively shall be determined according to the start number. In such a case, the athlete with the highest start number is the first to start.

If the number of participants is reduced prior to the final race heat, the eliminated athletes remain in the results with their final ranking. If in the final heat an athlete does not start or is disqualified, they do not receive a final ranking. The remaining athletes move up in the ranking list.

#### 10.6.16 Maintenance of the timing equipment (in place from 2017/18 season on)

a) For each season the timing equipment must be maintained by a professional company.

b) A maintenance report will be issued specifying the operations carried out during the maintenance.

c) Records must be kept of all existing deficiencies which cannot be corrected immediately through the regular maintenance activities (e. g. computer damage).

d) In the maintenance report it must be confirmed that the timing equipment is ready for use.

e) The track operator must submit the maintenance report to the IBSF Office prior to the first international competition.

#### 10.6.17 Use of push start facility

Iced or non-iced push start facilities – regardless of whether they are located inside or outside the venue – may not be used during the race days of Senior World Championships, Junior World Championships, Senior Olympic Winter Games or Youth Olympic Winter Games by any athletes who participate in that event. On non race days during the above Championship and Olympic events the push start facilities can only be used with the approval of the IBSF.

### 10.7 Parc Fermé

A Parc Fermé is utilized at every race.

The Parc Fermé is bordered by barricade fences and/or tape.

### 10.8 Material and Equipment

#### 10.8.1 Sled

In principle, all race heats must be contested with the same sled. If the sled has been damaged beyond immediate repair, a replacement sled may be allowed with the authorization of the Jury. All sleds must be approved by the Material Controller/Jury before the competition, and must carry an IBSF label. Replacement sleds used at the discretion of the Jury must be approved by the Material Controller/Jury immediately after the race heat for which it has been used.



## 10.8.2 Runners (General)

In all official IBSF races listed on the IBSF-Calendar (OWG, World Championships, Junior World Championships, Continental Championships, WC, ICC, EC, NAC, etc.) only IBSF standard runners (standard material) are admitted. The authenticity of the runner steel may be controlled by the IBSF Jury and/or IBSF Material Controller at any time. To define the authenticity of the runner steel, inspections may include the analysis of the composition of the runner material and examination of the hardness of the runner steel.

Only geometrical changes to standard IBSF runners through the removal of the original material are allowed. No materials (exceptions runner block and runner post) may be added in any way.

The use of any means of propulsion is prohibited.

Changing runners between race heats held on the same day is only permitted after damage and with the authorization of the Jury.

**At the Jury's discretion, runners can be subjected at any moment to inspection with special equipment.**

In case of inconclusive findings, runners may be seized and sent to a specialized laboratory for further testing.

On the occasion of:

- Olympic Winter Games
- Senior World Championships

Complete inspections can be conducted prior to the competition.

## 10.9 Technical Inspections

**The sleds participating in the race must be in the "Parc Fermé" (start area), positioned** in the spaces assigned to them. All preparatory work performed on the sleds, including mounting the runners, must be completed 45 minutes before the start of the race.

The sleds must be uncovered.

The sleds must be brought into the Parc Fermé with clean runners.

After this time point, no work may be performed on either the sleds or the runners. Changing runners and replacing sled parts is also prohibited. Only the person who must bring the sled to the start may enter the Parc Fermé.

The Parc Fermé is open for 10 minutes between the race heats. It is prohibited to bring tool boxes or anything **similar into the "Parc Fermé"**. It is also prohibited to wear gloves or to cover the hands by any other means.

During this time it is allowed to sand scratches (only) after inspection by the Jury.

The runners can only be polished using abrasives provided by the IBSF.

The runners must remain mounted on the sled, and the sleds must not be moved away from their assigned space to adjust the runners. The use of any other materials and / or products is prohibited. Violation of this rule is penalized with an immediate disqualification from the race.

The Jury can at any time confiscate the abrasives provided by the IBSF, regardless of whether they have been used or not.

Only the Jury, in agreement with the IBSF Material Controller, can give authorization for repair work to be performed on sleds with technical problems.

Between the individual race heats, no further work may be performed without the authorization of the Jury.

If a set of runners is so damaged during a race that immediate repair is not possible, the athlete has the possibility to use a new set of runners, after receiving the authorization of the Jury. The new set of runners is subject to the provisions of the IBSF International Rules.

All sleds and runners participating in the race can be subjected to technical inspections. The Jury decides which sleds and runners are to be inspected and when the inspection is to take place. Inspections of the other equipment can also be conducted. The Jury can assign the members of the IBSF Material Controller to carry out these inspections.

In cases of suspicion, components of the sled can be confiscated and subjected to technical inspections. The inspections can be conducted at a mobile laboratory on the competition site. In this case, the Jury evaluates the laboratory results immediately and takes the appropriate action.

If the technical inspections are conducted after the race at a laboratory outside of the competition site, the inspection results are forwarded to the IBSF Executive Committee. The laboratory in charge must be approved by the IBSF. The procedures used must be in accordance with article 13 of these Rules.

In case the results show proof of a violation against the IBSF International Rules, the IBSF Executive Committee takes the appropriate action. In this case, the National Federation concerned shall bear the costs of the inspection and appraisal. The decisions of the Executive Committee are incontestable.

If it is determined that the IBSF International Rules have been violated, then it automatically results in disqualification from the competition concerned.

#### 10.10 Runner Diameter

The Jury or the IBSF Material Controller checks the diameter of the runners with official IBSF gauges. The diameter of the runners may not be less than that of the gauge.

#### 10.11 Measurement of Runner Temperatures

The runner temperatures are checked before the start according to the instructions of the Jury. Both runners are checked with an electronic measuring device equipped with a temperature measuring sensor and a display device for temperatures between at least +30° C and -20° C.

The Organiser must provide two electronic measuring devices, one for the Jury and one for the athletes participating in the race.

The temperature of the runners is measured on the side of the runner in the area of the runner post. The measuring sensor shall remain in contact with the runner until the display on the temperature measuring device is stable.

The temperature of the runners that are mounted on the sled being used in the race may exceed the temperature of the reference runner by a maximum of 4° C. If the temperature of the reference runner is less than -14° C, the runners on the sled may have a maximum temperature of -10° C. **If an athlete's** runner temperature exceeds the limit, another measurement of the temperature of the reference runner and of the runner on the sled shall be made immediately following the first measurement. If the second measurement also shows a temperature that exceeds the limit, it leads to immediate disqualification. This is then registered in the Temperature Measurement Protocol.

The sled must be moved from its assigned place in the start area to the runner temperature measurement **station by carrying it (with runners away from the athlete's body)**. **Cooling down the runners by touching them with snow or ice is not allowed.**

## 10.12 Reference Runner

The temperature of the reference runner is measured according to the following procedure.

- a) The reference runner must be made of IBSF standard runner material. It must be hung or otherwise positioned in the open air one hour before the start of the race, in the same climactic weather conditions as the sleds included in the race. When the reference runner is positioned in the open air, it must show a temperature of between +18° C and +22° C.
- b) The exact temperature of the reference runner at the time it was positioned in the open air must be written on a clearly visible board in the start area. The board must also show the air and ice temperatures.
- c) The temperature of the reference runner is measured on the side of the runner in the area of the runner post.
- d) The temperatures shown on the temperature display board are updated as follows:
  - The first time, 60 minutes before the start of the race.
  - 15 minutes before the start of the race and 5 minutes before the start of the second heat.
  - In the case of extraordinary climactic conditions (high temperatures), after measuring the runner temperatures the Jury can instruct the athletes to place their sleds on the snow or ice immediately before the start.

## 10.13 Runner Cleaning

The runners are treated and cleaned before the start of the race heats with special cleaning solutions provided by the IBSF.

In every race in which the IBSF standard material is required, all runners are sanded with sandpaper in the same manner. It must be obvious that a characteristic amount of material has been removed. If this is not the case the Jury can decide to repeat the procedure, until sufficient material has been removed or disqualify the athlete; upon request of the Jury, sandpaper with a coarser grain size may be used. The sandpaper grade is determined by the IBSF before the start of the season. The Jury can call for a different grain on certain tracks.

The IBSF will publish a runner testing Protocol. If any runners are found to be outside the limits set by the Protocol the athlete can be sanctioned by the Jury. The sanctions available to the Jury are outlined in 8.10 of these rules.

## 10.14 Weight

The weight is checked using a scale.

Weights can be checked at any time upon decision of the Jury.

The sled and the athlete shall be weighed immediately after the conclusion of the race heat, upon request of the Jury. No modifications to the sled or the other equipment may be made. The first weight test is then made. Each athlete may request a second weight test, if necessary. For the second test, they have a maximum of 5 minutes to remove snow and ice from the sled. This occurs under the supervision of the Jury. Help from a third party is not allowed.

The observed weight must be registered in the Weight Protocol.

The combined weight of the sled and the athlete with complete race equipment may not exceed 115 Kg (women: 92 Kg).

The weight of the sled alone may not exceed 43 Kg (women: 35 Kg).

If the combined weight of the sled and the athlete with his equipment exceeds 115 Kg (women: 92 Kg), the weight of the sled along may not exceed 33 Kg (women: 29 Kg).

The maximum allowable weight can be reached by attaching ballast weights. The ballast weights must be affixed securely to the frame, base plate or the saddle. **Ballast weights on the athlete's body are prohibited.**

## 10.15 Electronic Measuring Devices and Equipment

In the time during which the track is subject to the control of the IBSF (e.g. official training, races, ITP and homologation), electronic or electrical measuring devices or equipment may not be used on the sled, on the athletes or on and beside the track. The IBSF or the Jury concerned has the power to grant exceptions such as specific measurements and/or POV recording (complete bobsleigh run), especially during a homologation of a track. In these cases the results of the measurements must be made known to all the participating National Federations. Footage obtained during homologation must be made available to all National Federations.

On and beside the track all coaching devices such as radios, ice thermometers and video recording devices are allowed, but this refers exclusively to such video recording devices, which are not **controlled remotely and/or stationary and aren't positioned closely or attached to the track.** Each National Federation is responsible to use these devices in a secure and safe manner.

TV cameras belonging to the track or IBSF Stakeholders are not subject to this article.

## 10.16 Other Equipment

### 10.16.1 Helmet

Wearing of a safety helmet is mandatory for all competitions, during both training and races. Only helmets whose shell and padding cover the head and at least the ear area are allowed. Each athlete who takes part in an IBSF Competition must wear a safety helmet approved by his / her National Federation.

Helmets with spoilers or protruding edges are not allowed.

The bottom edge of the helmet shell must maintain the shape of the helmets normally available on the market. Chin guards and clasps are not allowed to be positioned excessively low.

The chin guard, the visor and the hardware for attaching them are the only protruding elements allowed. These elements cannot, however, have aerodynamic coverings.

For safety reasons, all helmets must have a smooth surface.

A safety helmet

- has to be without any additionally attached aerodynamic elements or adhesive tape (except that used to fix the visor or the goggle strap), and
- the helmet shell must not have any concave shape except for the recesses for the visor, and
- the padding may protrude a maximum of 3 cm below the shell.

Please see the drawing in article 12.12.

### 10.16.2 Shoes

The use of spikes on the shoes of the athletes is allowed for pushing the sled, as long as the spikes are arranged in brush form.

The maximum diameter of the spikes may not be greater than 1.5 mm, the spikes may not be longer than 5 mm and the minimum amount of spikes per shoe must not be less than 250.

Shoe coverings are prohibited.

### 10.16.3 Clothing

Training and race suits with short pants and short sleeves are not allowed.

No aerodynamic elements whatsoever may be attached either outside or under the race suit. If the Race suit has a hood attached, this must be worn completely or removed completely from the suit. The hood of the suit is not permitted to be tucked in, rolled, sewed into place or otherwise used in a fashion **other than its intended purpose; to cover the athlete's head.**

Race suits must be manufactured from an uncoated textile.

## 10.17 Awards

### 10.17.1 IBSF Championships

At official IBSF Championships, the IBSF awards gold, silver and bronze medals to the first, second and third placed athletes. The fourth, fifth and sixth placed athletes receive commemorative medals. The Organiser awards additional honorary prizes to the athletes.

### 10.17.2 Official IBSF Competitions

The Organiser awards honorary prizes to the first to sixth placed athletes.

## 10.18 Awards Ceremony

The awards ceremony should take place as soon as possible after the deadline for submitting protests.

The doping controls and technical inspections may also take place after the awards ceremony.

At all IBSF Championships and official IBSF competitions, the national flags of the first three placed athletes must be hoisted. The national anthem of the winning athlete must also be played.

## 10.19 Protests

Protests must be made verbally to the Jury immediately or at the utmost 5 minutes after the heat in which that incident happened. Additionally, the grounds for the protest must be submitted in writing to the Jury no more than 20 minutes after the conclusion of the race.

If no verbal declaration of protest is made, no written protest may be subsequently submitted.

Only the team captain may submit verbal and written protests. Collective protests are not allowed.

No protests are accepted after the submission deadline passes.

**A fee in the value of € 100** shall be paid with the submission of the written protest. If the protest is rejected, the fee is forfeited in favor of the IBSF. Otherwise, the protest fee is returned.

The decision regarding a protest submitted during a race shall be made in a timely manner to allow the athlete affected by the protest to potentially continue to participate in the race.

In cases of protests submitted after the conclusion of the race, the Jury will announce its decision no more than one hour after the submission of the protest, if possible.

The decision of the Jury is determined by a simple majority of votes. If the votes are equal, the Jury President casts the deciding vote. Jury Assistants do not have the right to vote.

The decision of the Jury is final, incontestable and takes effect immediately.

## 11. RANKING LISTS

### 11.1 Ranking List of the Race Series

For the World Cup, Intercontinental Cup, North American Cup, Europe Cup and Youth Series, there are overall ranking lists (Men/Women) issued at the end of the season whereas the best results of each athlete in the particular race series are added up. The winner of the overall WC/ICC/EC/NAC/Youth is the athlete with the most points from the competitions in the particular race series. The first, second and third placed athletes in the overall ranking lists of each series, receive awards.

### 11.2 IBSF Ranking List

During the current season, the best results of each athlete are totaled by name for the IBSF Ranking List, regardless of the race series, or World Championships, in which the results were scored. It is consulted as an adjusted ranking list to determine the various quotas. The juniors are highlighted. The number of races scored is equal to the number of World Cup races carried out up to that specific date during the current season.

The IBSF Ranking List for ICC, NAC and EC is updated weekly, at the latest on Tuesday of each week. With regards to the World Cup, the IBSF Ranking List is updated after each race.

The IBSF Ranking List serves to determine the Starting Order for the World Cup, Intercontinental Cup, North American Cup and Europe Cup races of the current season as well as for the first competition for each Series of the following competition season. If the ICC, NAC and or EC start before the WC the current ranking list of the corresponding series will be used to determine the starting order (updated once weekly from the second week on, at the latest on Tuesday of each week).

The IBSF Ranking List serves to determine the Nation Quotas and the Starting Order for the Olympic Winter Games and the World Championships.

The IBSF Ranking List serves to determine the Nation Quotas for the World Cup, Intercontinental Cup, North American Cup and Europe Cup races of the following season.

The top-ranked athletes of a nation determine the nation quotas for the World Cup competitions, the next-ranked athletes determine the quotas for the Intercontinental Cup competitions and subsequently the quotas for the North American Cup and Europe Cup competitions.

For the Senior World Championships the World Cup Points Table is applied, for the Junior World Championships the new ICC Points Table according to 11.3 is applied.

If an athlete sits out for a season, he is scored with 50% of his points achieved on the IBSF Ranking List for the first race of the following season.

In cases of equal points, the following decision criteria apply to the IBSF Ranking List:

- first, the highest single point score;
- next, in the event of a draw, the better scores at the race immediately previous (World Cup points are of higher priority than points obtained in the other race series)

### 11.3 IBSF Ranking List - Points

WC and WCh.		ICC and JWCh.		NAC/EC	
Rank	Points	Rank	Points	Rank	Points
1	225	1	120	1	75
2	210	2	110	2	65
3	200	3	102	3	55
4	192	4	96	4	50
5	184	5	92	5	45
6	176	6	88	6	40
7	168	7	84	7	38
8	160	8	80	8	36
9	152	9	76	9	34
10	144	10	72	10	32
11	136	11	68	11	30
12	128	12	64	12	28
13	120	13	60	13	26
14	112	14	56	14	24
15	104	15	52	15	22
16	96	16	48	16	20
17	88	17	44	17	18
18	80	18	40	18	16
19	74	19	37	19	14
20	68	20	34	20	12
21	62	21	31	21	10
22	56	22	28	22	9
23	50	23	25	23	8
24	45	24	22	24	7
25	40	25	20	25	6
26	36	26	18	26	5
27	32	27	16	27	4
28	28	28	14	28	3
29	24	29	12	29	2
30	20	30	10	30	1

## 12. SKELETON SLEDS WITH DRAWINGS

### 12.1 Basic Principles

- Skeletons are sleds with two runners that are used in races that are carried out on iced tracks.
- To propel the sled, only the pushing force of the athlete, when starting, and the force of gravity are allowed.
- **All devices that help the sled's descent, particularly those capable of being used to steer or brake the sled in an active manner and with moving parts, are prohibited.**
- No hydraulic, pneumatic or electrical devices of any kind are allowed on the sled.
- Sled manufacturers are responsible for ensuring that the sled is constructed in such a way that it can withstand the strain of repeated runs on bob tracks without damage.  
Also, the sled must be constructed in such a way that the runners may be adjusted without removing the sled from the assigned space (standing) during the races.
- In official competitions, after completion of the work in the Parc Fermé, **the sled's specifications** may no longer be modified in any way, other than through accidental damage.
- The Jury and / or the IBSF Material Controller must be able to check the specifications of all construction elements without significant technical effort.

### 12.2 Construction

- In general, the skeleton sled is composed of the following construction elements:
  - construction frame with runner supports and runner post guides
  - saddle (supporting plate including handles)
  - cowling (pan, base plate, sled body, pod)
  - ballast
  - runners with runner blocks and runner posts
  - bumpers
  - sled coverings (supporting surface: padding, tape, etc.)
- The dimensions indicated in the drawings, diagrams and figures are compulsory.
- The weight of the sled is specified in the IBSF International Skeleton Rules.
- Protruding items that could cause injury are prohibited.
- Fairings, spoilers and aerodynamic elements are prohibited. The cowling is not considered to be a fairing.
- For the purpose of the IBSF, **the term "steel" means an alloy of iron and carbon with an iron (Fe) content of more than 50%, or an alloy that reacts positively to the IBSF chemical test.**
- This does not apply to certain specifically described sled components.
- No sprung, rubber, rubber-like or energy absorbing materials or elements may be used in the sled components or in the mechanical joints between them.  
Exceptions:
  - mounting locations of the cowling on to the construction frame (Figure 8)
  - openings of the cowling
  - coverings on the supporting surface and the saddle
  - filling up hollow spaces under the supporting surface (Figure 6)
  - between the construction frame and the cowling
- It is accepted that the runner loaded in the construction frame could cause a sprung effect.



### 12.3 Dimensions (Figures 1, 2 & 3)

- Sled length: 800 – 1200 mm
- Overall sled height: 80 – 200 mm (as prepared for the race)
- Runner gauge: 340 – 380 mm from runner center to runner center

### 12.4 Construction Frame (Figures 1 & 2)

- The construction frame consists of longitudinal and transverse bars and runner supports, which must be made of steel. Each of the two longitudinal bars must be constructed of a continuous piece of steel, with a minimum rectangular cross section of 30 mm wide x 5 mm high. (Figure 4) Each of the two transverse bars must be constructed of a continuous piece of steel, with a minimum rectangular cross section of 25 mm wide x 3 mm high. (Figure 4)
- Any additional elements on the construction frame must be bolted or welded and **made of steel**.
- The runner supports must be rigidly attached to the construction frame. The runner supports are defined as the parts with slots and do not include any elements that have been welded on. (Figure 7)
- **The corner connecting joints must attach the frame's bars firmly and rigidly** to each other or to the runner supports. These joints may be welded or bolted with a minimum of 2 bolts per joint. There may be a vertical separation between the transverse bar and the longitudinal bar of not more than 2 mm. (Figure 7)
- The front transverse bar must be attached in the region of the runner support. The maximum permitted distance between the front end of the runner support and the transverse bar is 80 mm. The rear transverse bar must be attached in the region of the runner support. The maximum permitted distance between the rear end of the runner support and the transverse bar is 30 mm.
- The runner post guide may have maximum dimensions of 25 mm wide x 45 mm long. It must be rigidly attached to the construction frame.

### 12.5 Saddle (Figures 1, 2 & 3)

The saddle must be made of solid steel. It must be mounted on the construction frame. It may be divided into a maximum of two pieces. No handles, howsoever they are constructed, are permitted on the saddle.

The minimum distance prescribed between the saddle above the supporting surface is 100 mm (Figure 1). The saddle must be covered at all points where it is above the supporting surface. No handles, however constructed, are permitted. **The athlete's arms must be outside the saddle during each run.**

- Each side of the saddle may have a maximum of three openings; two with a maximum length of 120 mm each. The maximum distance allowed for the third opening, from the start of the opening to the rear most part of the saddle is 150 mm. (Figure 2)
- The saddle may not move laterally. If the saddle is constructed of two pieces, then they may not influence one another in movement. (Figures 1 & 3)
- The lowest point, front and back, of the saddle (in the longitudinal axis) may not be higher than the supporting surface.

## 12.6 Cowling

- The cowling must be constructed in one single piece. The cowling must be convex throughout (maximum allowable concavity over 300 mm is 3 mm). Exception:
  - within an area of 80 mm from the front edge (Figures 1 & 3)
- Multiple local protrusions or depressions are not allowed.
- The construction frame and the cowling must be two separate pieces. Laminating the construction frame in to the cowling is not allowed. Exception:
  - 4 lamination strips with a maximum width of 50 mm (Figure 8)
- The cowling may be mounted to the construction frame by welding, gluing, bolting or riveting.
- The upper edge of the cowling may not be higher than the supporting surface.

## 12.7 Weights

- Ballast weights may be attached to the sled to reach the maximum permitted weight limit.
- Ballast weights must be affixed securely to the frame, base plate or saddle.

## 12.8 Runners (Figure 5)

- The runner blocks and runner posts must be welded to the runner.
- The runners must be mounted directly to the runner supports.
- Every runner must be constructed from one solid piece of the standard material according to IBSF specifications and must not exceed 280 Brinell (HB). The standard material is produced and distributed by a factory designated by the IBSF
- The material is supplied as polished round bars with a diameter of 16 mm (h9 tolerance class) and a length of 1000 mm,  $-0/+50$  mm. The material is always supplied with markings. These markings must always be present on the runners and must not be altered in any way.
- All types of treatment are forbidden, including those which cause even only a local variation of the physical characteristics (\*) and / or the composition and / or the structure of the material.
- No plating and/or coating is allowed
- The diameter of the steel runner must be 16 mm along its entire length right up to the joints with the runner supports and the runner posts (a shortfall of up to 0.50 mm is permissible).
- The grooves and milled areas on the runners must be formed in such a way as to avoid any excessive damage to the ice surface of the track. The depths of the millings and grooves, measured from the surface of the ice, must not be greater than 2 mm.
- By order of the Jury the runners maybe confiscated for in-depth inspection subject to protocol.

**Note (\*): The term “physical” is to be understood as a global term which comprises all specific terms like, for example, “mechanical”, “tribological”, “electromagnetic”, etc.**

## 12.9 Bumpers (Figures 1, 2 & 3)

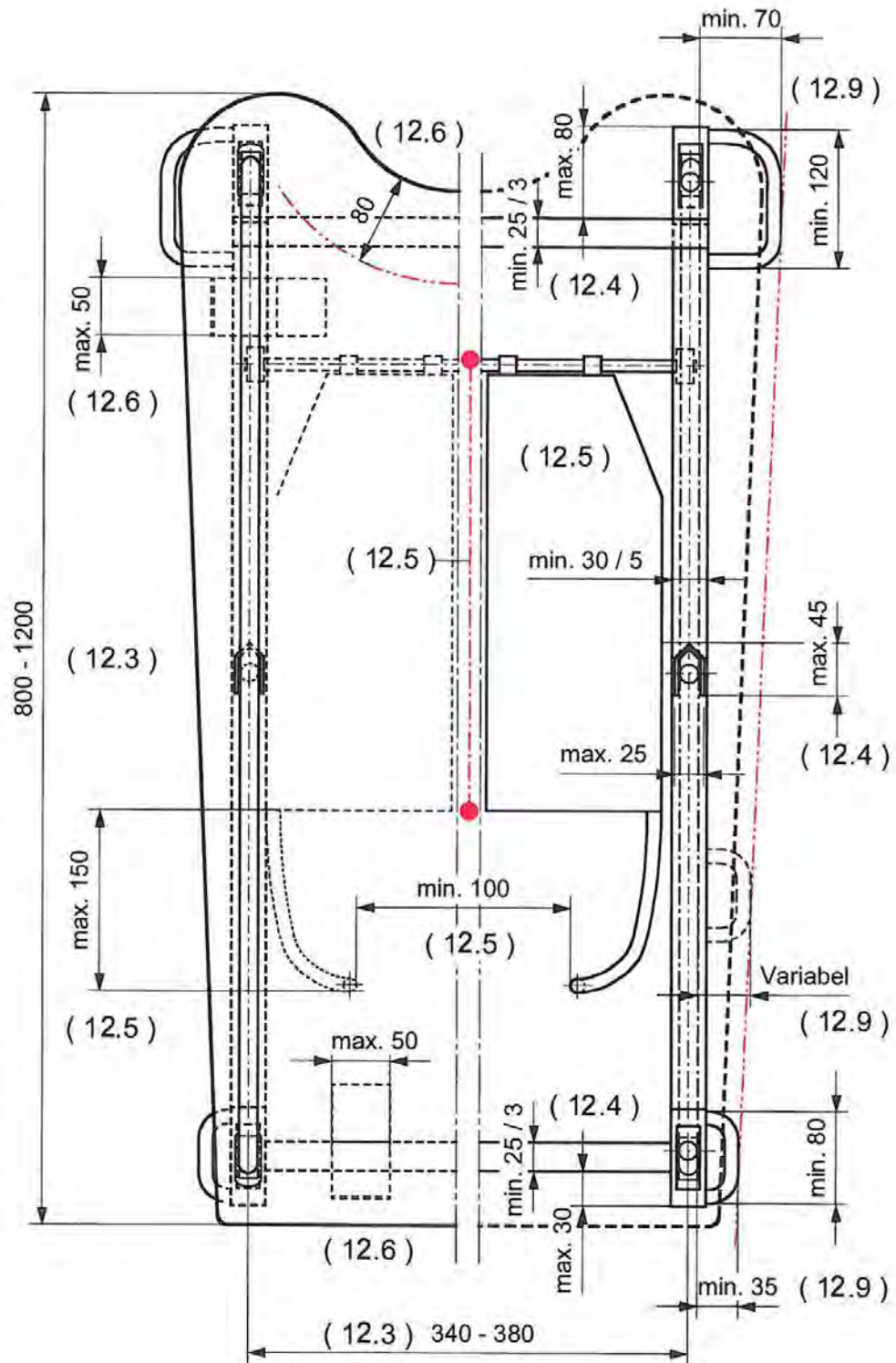
- Secure bumpers must be mounted on the front of the sled on both sides. The minimum permitted distance between the outside edge of the runner and the outside edge of the front bumper is 70 mm. The minimum permitted length of each front bumper is 120 mm. The front bumpers may only protrude a maximum of 15 mm on the left and right outside edge above the supporting surface.
- Equally secure bumpers must also be mounted between the saddle and the rear end of the sled. The minimum permitted distance between the outside edge of the runner and the outside edge of the rear bumper is 35 mm (measured at the rear runner support). The minimum permitted length of the rear bumper is 80 mm. They may not protrude laterally beyond the front bumpers.

- If the rear bumper is mounted in the direction of the middle of the sled, the outside dimension must increase in a straight line to the front bumper.
- All bumpers must be constructed of one single piece of round steel (exception: mounting onto the construction frame). They must extend far enough beyond the base plate to allow them to be checked at any time. Minimum diameter is 12 mm. Minimum measurement of worn bumpers is 11 mm.
- It is the responsibility of the sled builders to produce bumpers with sufficient durability to be able to withstand repeated contact with the track walls.

#### 12.10 Sled Coverings

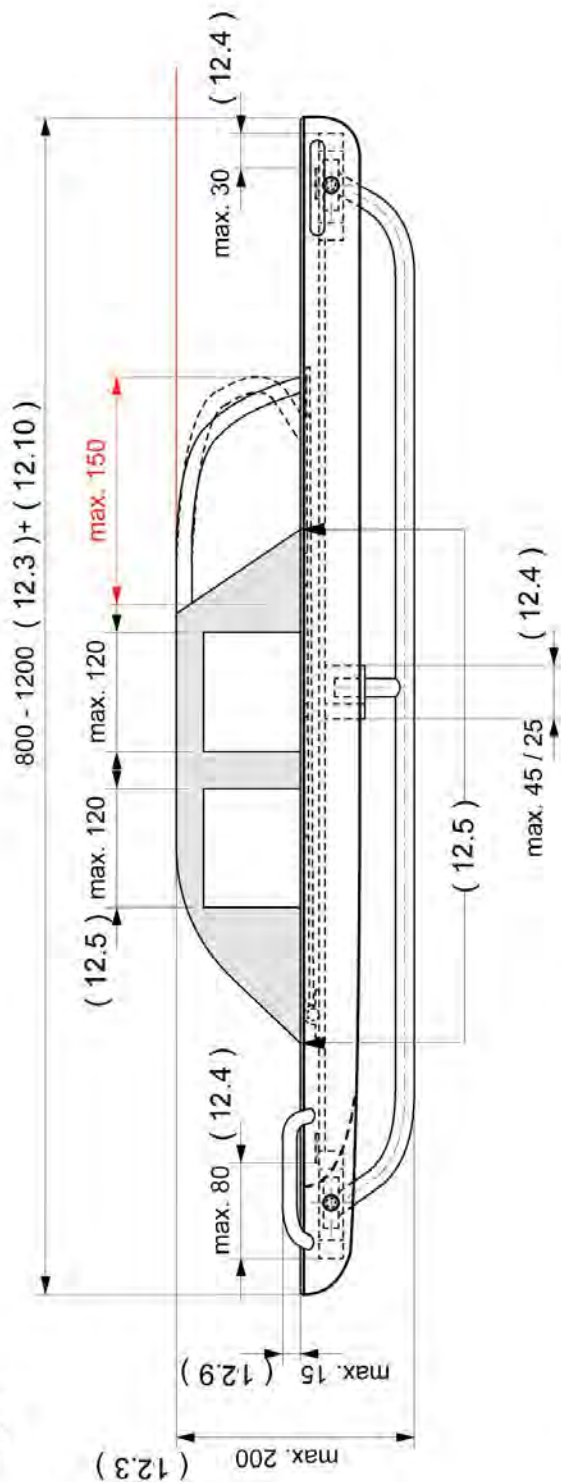
- The padding of the supporting surface at the front, rear and sides of the saddle (outside) must be horizontally flat. The width is determined by the outside edge of the sled. (Figure 3)
- No elevations, depressions or openings are allowed. This also applies to the inside of the saddle.
- Any protruding or sharp elements on the sled must be covered adequately, in order to avoid possible injury to athletes
- Sled coverings must be easily removable. (Figure 6)

12.11 Drawings

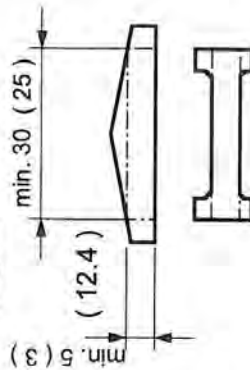


**Fig. 1** (0.0) = Art. Nr.  
 ALLE MASSE IN MM / ALL DIMENS. IN MM /

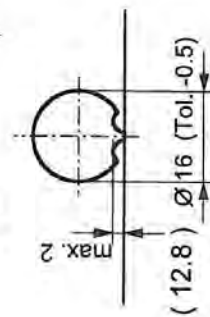
**Fig. 2**



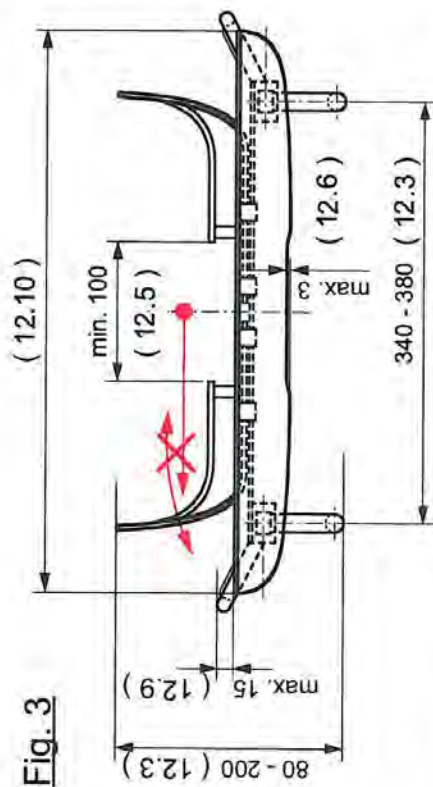
**Fig. 4**



**Fig. 5**



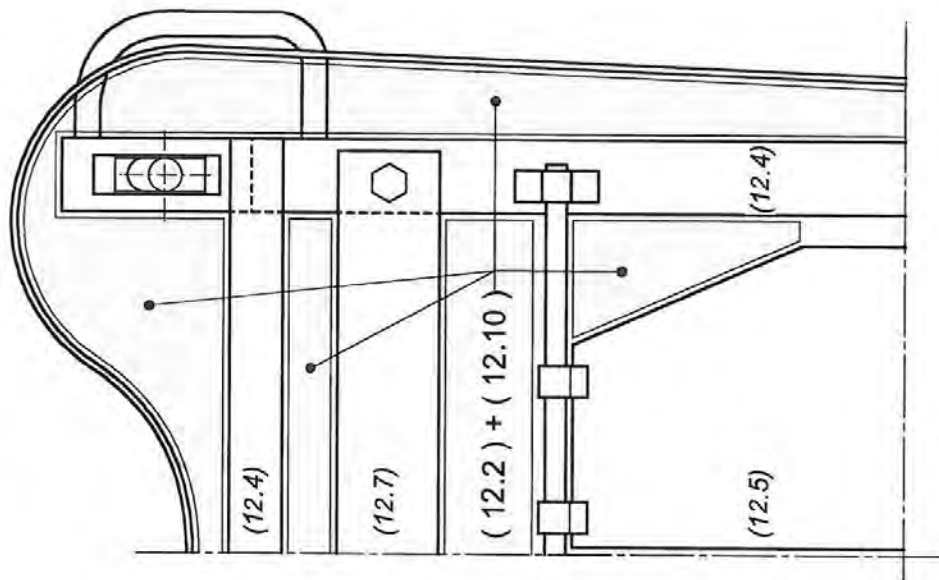
**Fig. 3**



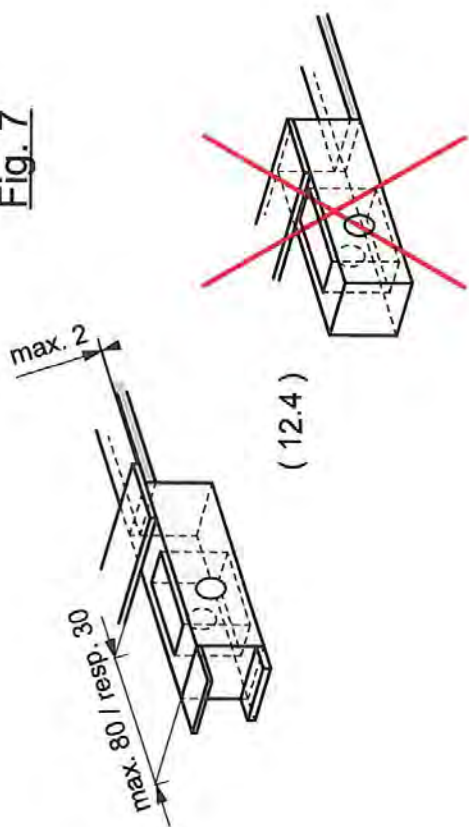
(0.0) = Art. Nr.

ALLE MASSE IN MM / ALL DIMENS. IN MM

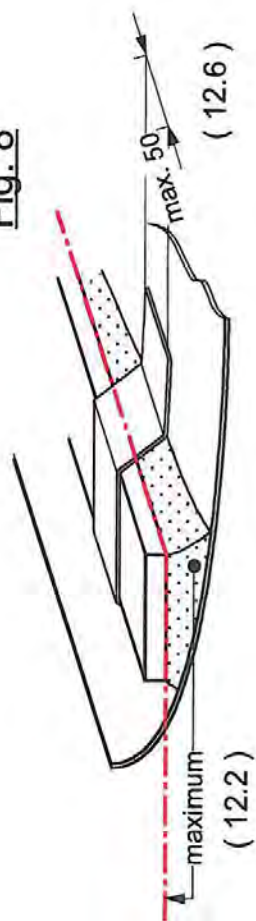
**Fig. 6** (BEISPIELE / EXAMPLES)



**Fig. 7**

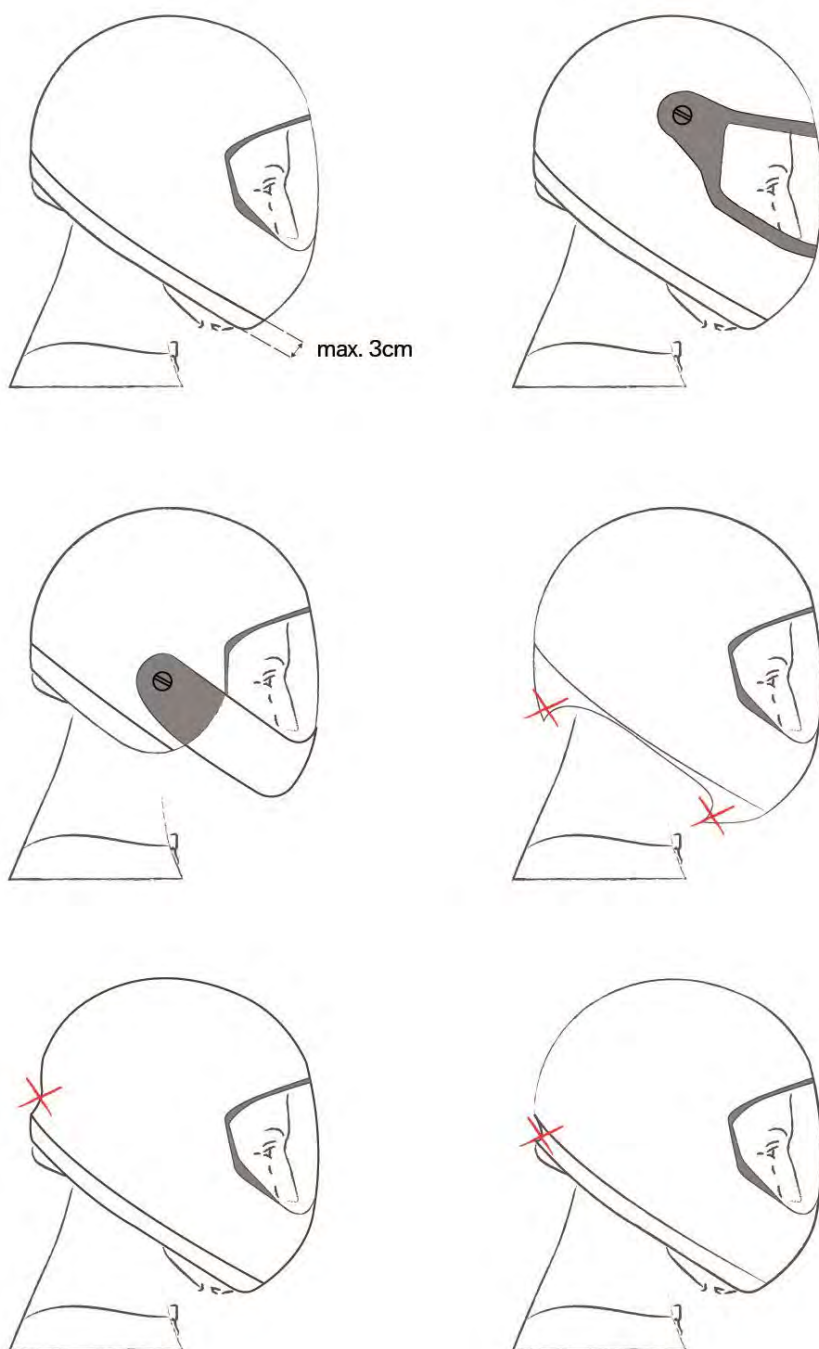




**Fig. 8**



( 0.0 ) = Art. Nr. ALLE MASSE IN MM / ALL DIMENS. IN MM

12.12 Equipment



-  concave form allowed
-  no aerodynamic modification allowed

Drawing for article 10.16.1

## 13. MATERIAL SEIZURE

### 13.1 Procedure for the seizure of sled components for conformity tests

Empowered by the Jury and in the presence of at least one of its members, the IBSF Material Controller responsible directs the official representative of the Federation to which the sled belongs to remove or disassemble the component(s) to be tested.

### 13.2 The Form

Upon collecting the component(s), the IBSF Material Controller will fill in a form drawn up in six copies, stating:

- general data of the team / athlete whose sled is being tested
- the name of the competition and the venue
- the date and time
- a description of the component(s) taken
- the type of test(s) the laboratory is required to perform
- a blank space for entering the laboratory analysis results

The following people will sign the form:

- the Jury President
- the representative of the IBSF Material Controller
- the team captain or official representative of the Federation to whom the sled belongs

The five copies of the form will be sent to the following:

- one copy to the Jury President
- one copy to the IBSF President (via the Secretary General)
- one copy to the team captain or official representative of the Federation to whom the sled belongs
- two copies to the laboratory, together with the container holding the component(s) to be tested

By returning one of the two copies of the form to the IBSF Secretary General, the laboratory confirms that it has received the container undamaged.

### 13.3 The Container

The seized components will be sealed in a container.

### 13.4 Remarks

The IBSF bears the costs of the laboratory analysis. In case of positive analysis results, the IBSF can order the costs to be reimbursed by the Federation to whom the sled belongs.



PROTOCOL FOR SEIZURE OF SLED COMPONENTS FOR CONFORMITY TESTS

Place: \_\_\_\_\_ Date: \_\_\_\_\_ Time: \_\_\_\_\_ Competition: \_\_\_\_\_

Event: \_\_\_\_\_ Nation: \_\_\_\_\_

Description of component/s taken: \_\_\_\_\_

Test/s required: \_\_\_\_\_

Name of Laboratory: \_\_\_\_\_

Laboratory result: \_\_\_\_\_

President of Jury                      Material Controller                      National Federation

Name: \_\_\_\_\_ Name: \_\_\_\_\_ Name: \_\_\_\_\_

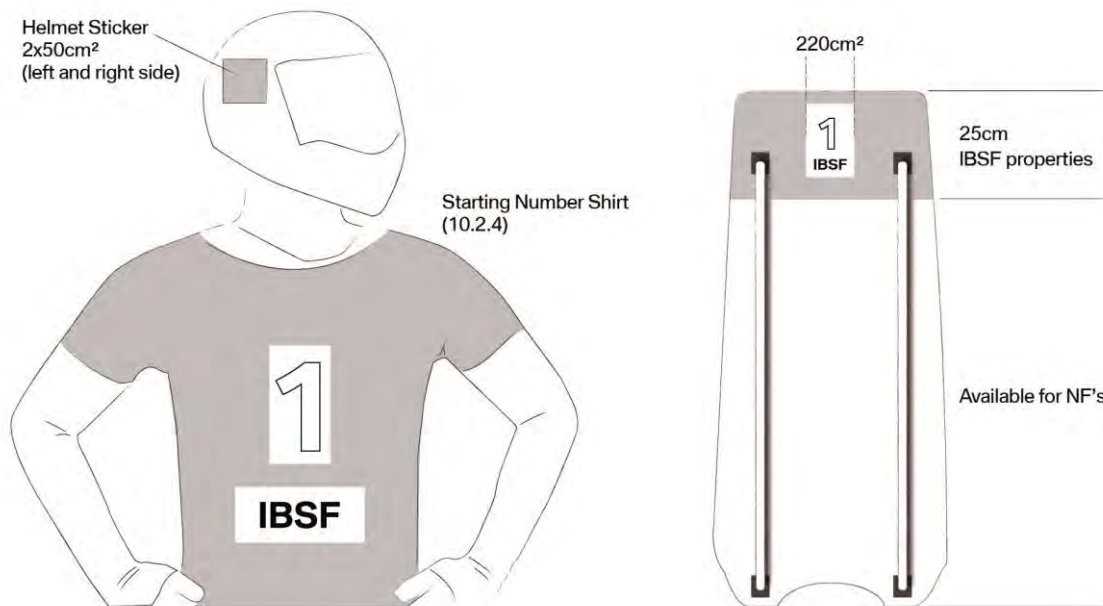
Signatures: \_\_\_\_\_

The Laboratory \_\_\_\_\_ in the person of Mr. \_\_\_\_\_  
acknowledges receipt of the official container bearing unbroken seals, from Mr.

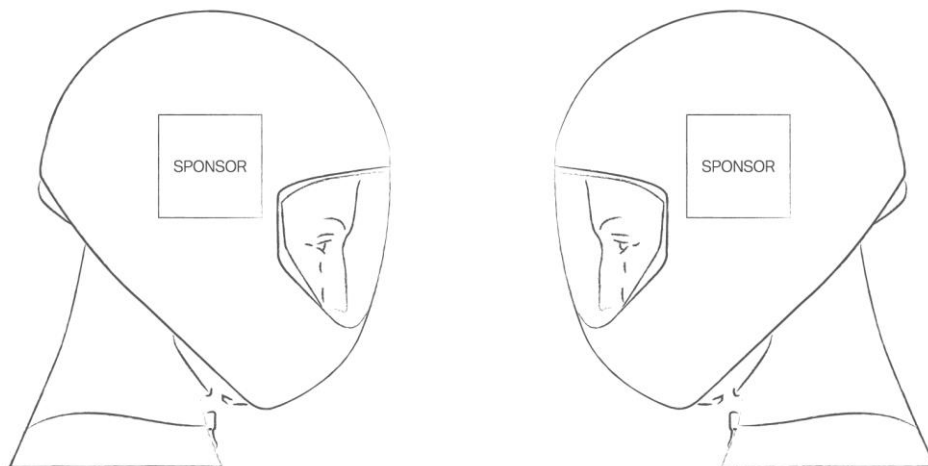
\_\_\_\_\_ on (date) \_\_\_\_\_ at (time) \_\_\_\_\_

Stamp: \_\_\_\_\_  
(signature)

## 14. ADVERTISING GUIDELINES AND DRAWINGS



- IBSF properties / Fläche für IBSF
- Available for NF's / Den NV zur Verfügung stehend



IBSF properties: helmet (bob & skeleton)  
 Left and right side of the helmet, as close as possible to the visor  
 Size: 50cm<sup>2</sup>

---

## 15. FINAL CLAUSES

### 15.1 Coming into Force

This edition comes into force on October 1<sup>st</sup>, 2017.

### 15.2 Modifications

The IBSF Executive Committee determines modifications to the IBSF International Rules.

### 15.3 Interpretation

If an article in these Rules should be ambiguously defined so that multiple interpretations are possible, the interpretation should be used that matches the underlying meaning for which the article was written.

## GLOSSARY

Term / Abbreviation	Definition
DSQ – Disqualified	A ruling by officials that an athlete or team has broken or failed to observe the rules of the sport and cannot be considered for placing in the competition.
DNS – Did Not Start	If an athlete or team has been drawn for the competition but did not start.
DNF – Did Not Finish	If an athlete or team does not cross the finish timing eye.
Member = National Federation = Nation	These three terms are used synonymously describing the National Federations that are Members of the IBSF representing their country internationally in bobsleigh and/or skeleton sport (IBSF events). They have to comply with IBSF Rules and Regulations.
Congress	The Congress is the highest authority of the IBSF, and it consists of the Delegates nominated by the Members and the Executive Committee.
Quota	A restriction that limits the number of participants in any IBSF competition and Olympic Winter Games.
Ranking List	A listing of athletes/teams according to IBSF system of rating for each series.
to be ranked	All athletes that finish the race without being classified as DNS, DNF or DSQ are being ranked in a race.
International Jury License	A formal permission from IBSF to a person to take part in the official IBSF competitions as a Jury President or Jury Member. To obtain it the candidate has to pass the International Jury Exam.
Abrasive	Material (e.g. sandpaper) used to polish the runners.
Gauge	An instrument used to measure the runner radius.
Electronic Measuring Devices	Any instruments used to measure speed, temperature, G-force etc.
OWG	Olympic Winter Games
WC	World Cup
WCH	World Championships
EC	Europe Cup
ECH	European Championships
ICC	Intercontinental Cup
NAC	North American Cup
ITP	International Training Period